

AETES

ERM 48VDC to AC Inverter

Pure Sine Wave AC Output

Useful LCD Front Panel

Small Size Design



"...power alliance..."

Description

AETES ERM Series Inverters is a high technology equipment, including all protection and control systems, which is designed and manufactured to convert an 48VDC voltage to pure sinus and regulated AC voltage with a predefined frequency. It provides AC power, which is especially important for Industrial, Telecom and Energy projects.

This equipment contains internal line filters, it provides full electrical quality between DC and AC input supplies and AC output, and uses all advantages of Digital Signal Processor control. It provides also handy user interface and advanced communication features.

Features

- Useful LCD Display, Showing Measurements, Status and Alarm Message
- Low Output Voltage Harmonics
- Advanced Communication Options for Remote Monitoring
- AC By-pass Input with wide Voltage and Frequency Range
- Excellent Short Circuit Protection
- Overload and Over Temperature Protections
- Precise Output Frequency Regulation
- High Efficiency thanks to CPU Controlled Design
- Dry Contact Outputs and RS232, RS485 ports for Status Indication
- Lightweight and Slim Structure Provided by the Latest Semiconductor Technology

Specification

ITEMS	MODEL	ERM-048-1P3-2K5	ERM-048-1P3-5K0	ERM-048-1P3-7K5	ERM-048-1P3-10K
Output Power (Continuous) Output		2500VA/ 2000W	5000VA/ 4000W	7500VA/ 6000W	10kVA/ 8kW
Power Boost Capability		2400W for 60s.	4800W for 60s.	7200W for 60s.	9.6kW for 60s.
Output Peak Capability		2800W for 10s.	5600W for 10s.	8400W for 10s.	11.2kW for 10s.
Input Voltage Range		42V...59V DC (Starting 46V...57V DC)			
Output Voltage		1-Phase (P-N) 110V or 220V AC (Order Option)			
Output Frequency		50Hz or 60Hz $\pm 0.1\%$ (Order Option)			
High Voltage Protection		Yes			
Output Over Load Protection		Yes			
Over Temperature Protection		Yes			
Short-Circuit Protection		Yes			
Efficiency Typ.		$>85\%$			
Line Regulation (max.)		$\leq \pm 2\%$			
Load Regulation (max.)		$\leq \pm 5\%$			
THD Linear (max.)		$\leq \pm 3\%$			
Communication		RS232 & RS485			
Status Indicators		4 LED & 5 Dry Contacts			
Remote Monitoring		TCP / SNMP (Optional)			
AC By-Pass Transfer Time		$\leq 6\text{ms}$			
Enclosure Material / Color		Metal / Black			
Cooling		Internal Fan-Forced			
Operating Temperature		-10°C to $+50^{\circ}\text{C}$			
Storage Temperature		-30°C to $+70^{\circ}\text{C}$			
Humidity (Non Condensing)		20-90% RH operating and non operating			
Withstand Voltage (One Minute)		Input to Ground 1500VAC, Input to Output 1500VAC, Output to Ground 1500VAC			
Isolation Resistance		$>50\text{M}\Omega$ at $+25^{\circ}\text{C}$ & 95%RH, Output to Ground 500VDC			
Safety Compatibility		EN60950-1			
EMI Compatibility		EN55032 Class B			
Weight (Typ)		11 kg	14 kg	23 kg	25 kg
Dimensions		B:2U D:350 E:444 mm	B:2U D:430 E:444 mm	B:4U D:470 E:444 mm	B:4U D:470 E:444 mm
Warranty		2-Year			

Rear Panel

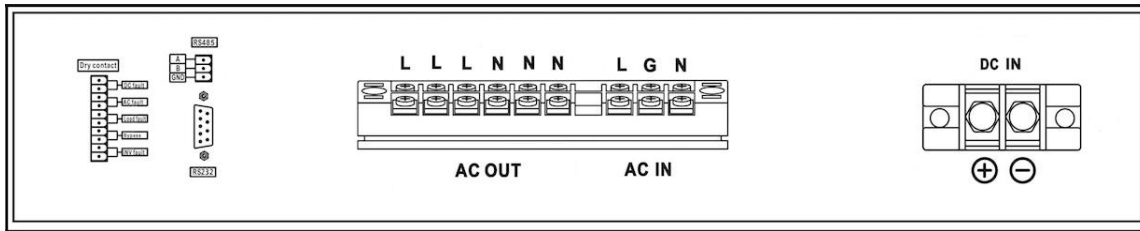

Block Diagram

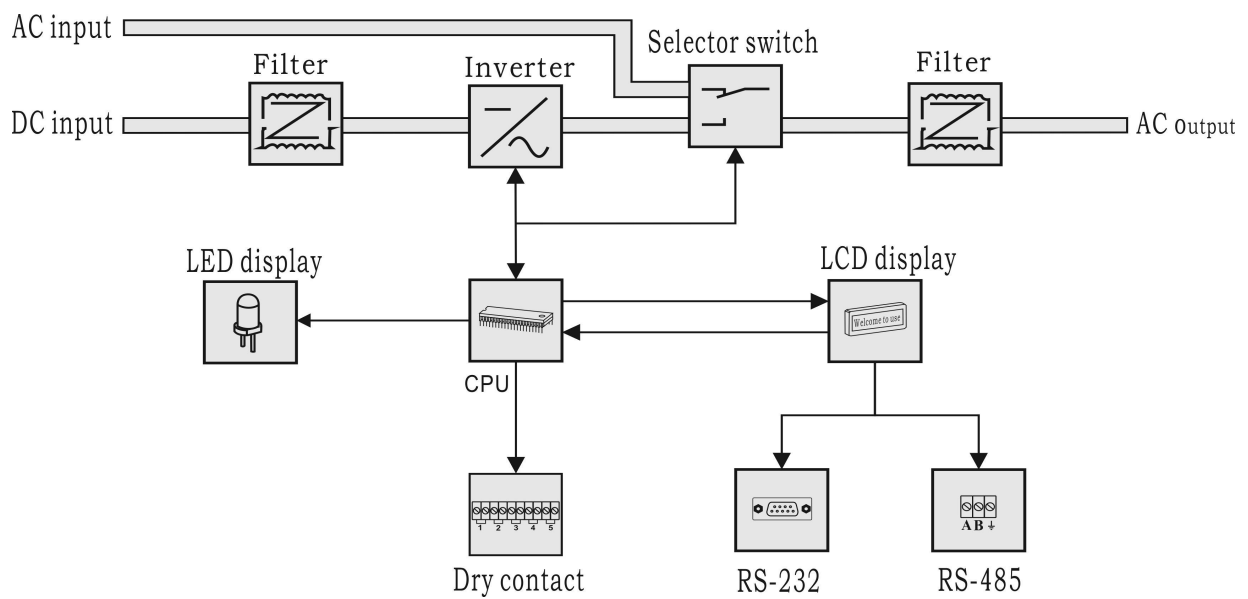

DC MODE (Inverter)

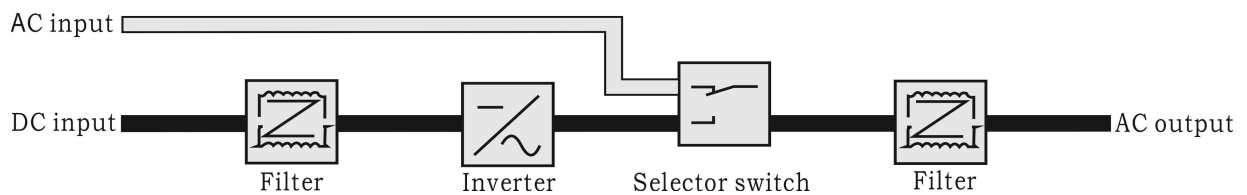

AC MODE (By-Pass)

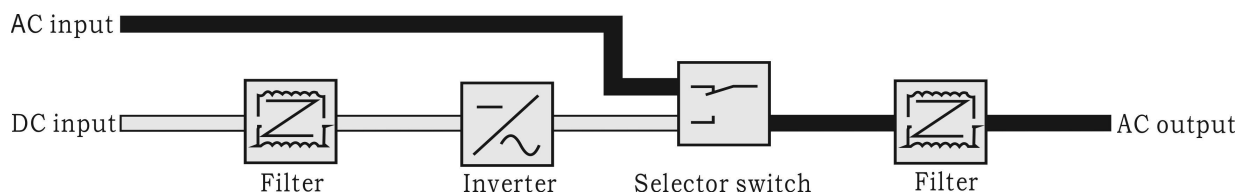

Drawing

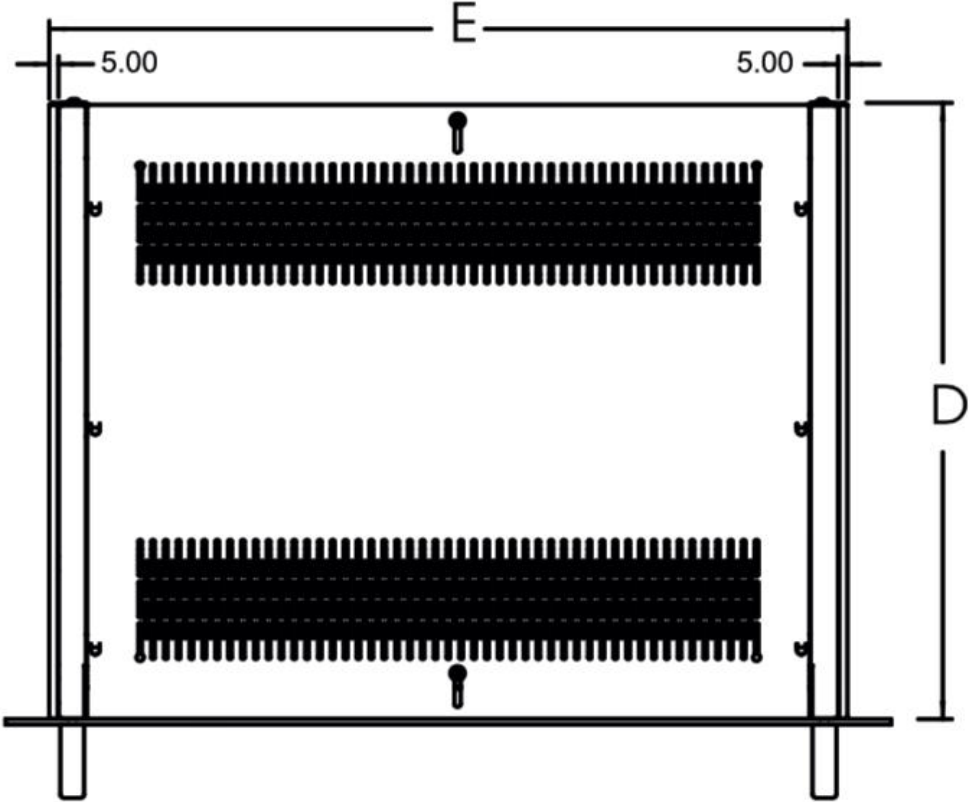

"...power alliance..."

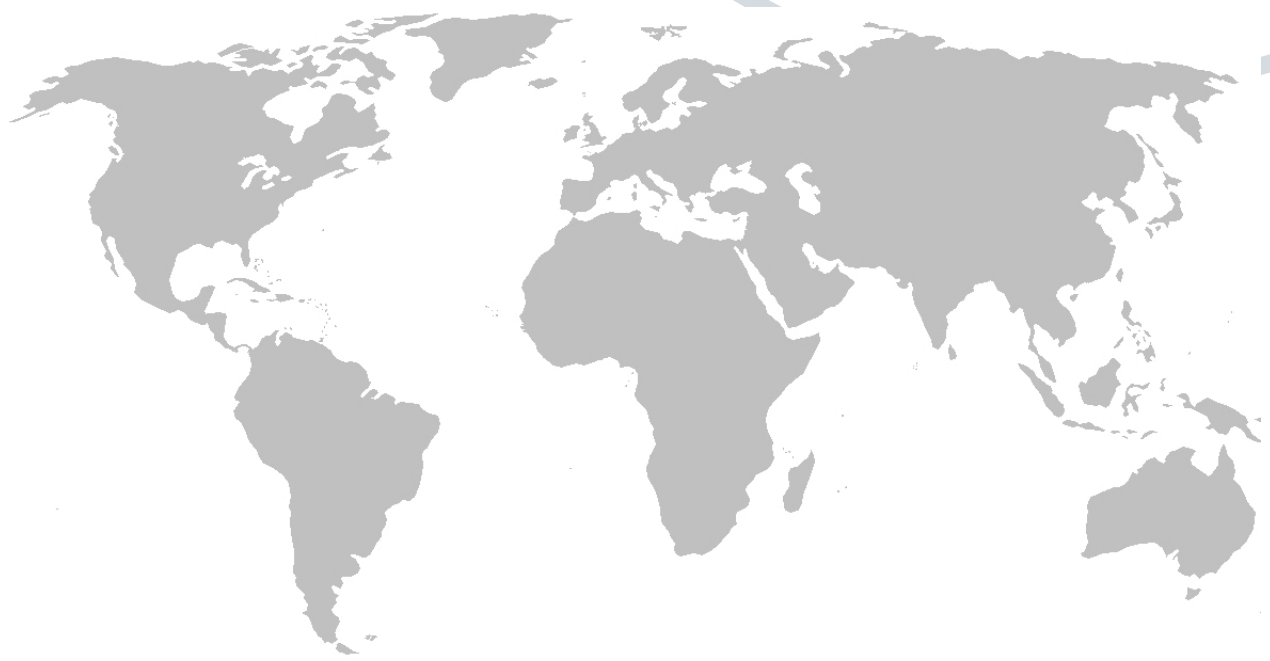
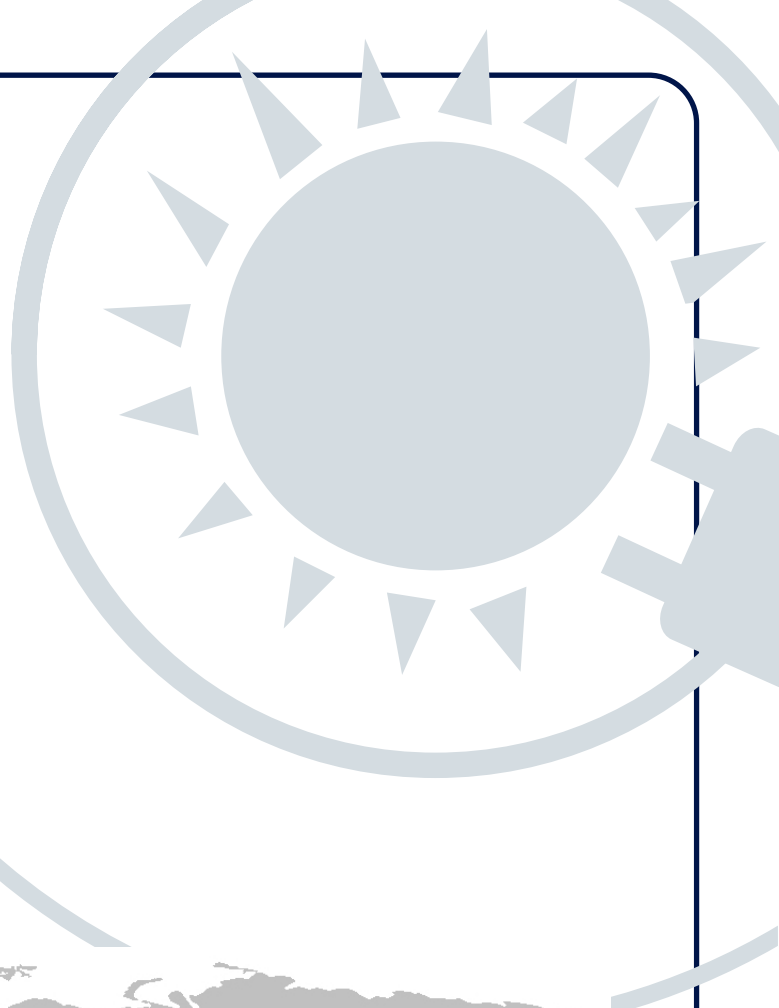

AETES
"...power alliance..."

The specifications, drawings and images indicated in this document are based on current information. All content is subject to modifications or additions. For more information on our local sales offices, visit us at our website below.